

# LEVANTE

design Marco Spatti

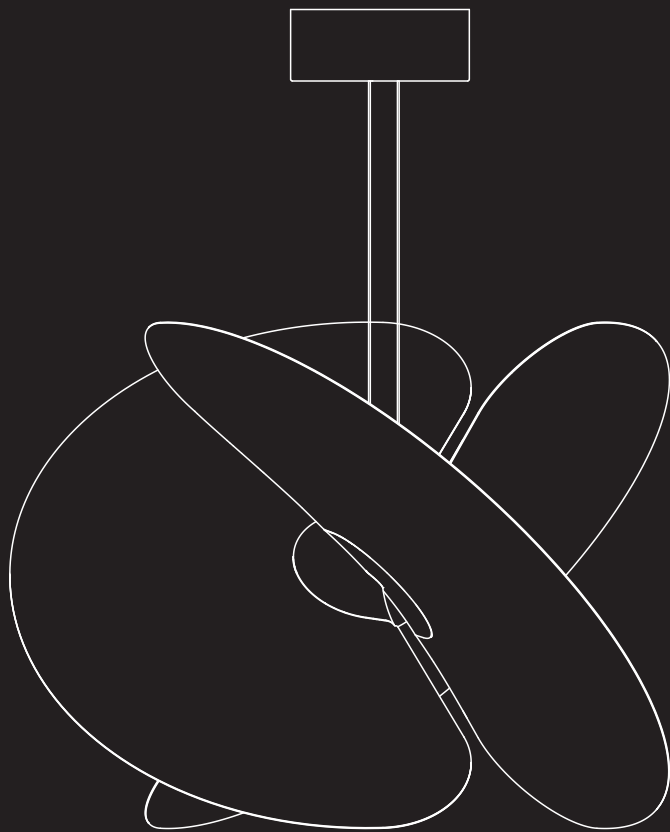

**LUCE  
PLAN**

A06



## A06/1T - A06/2T

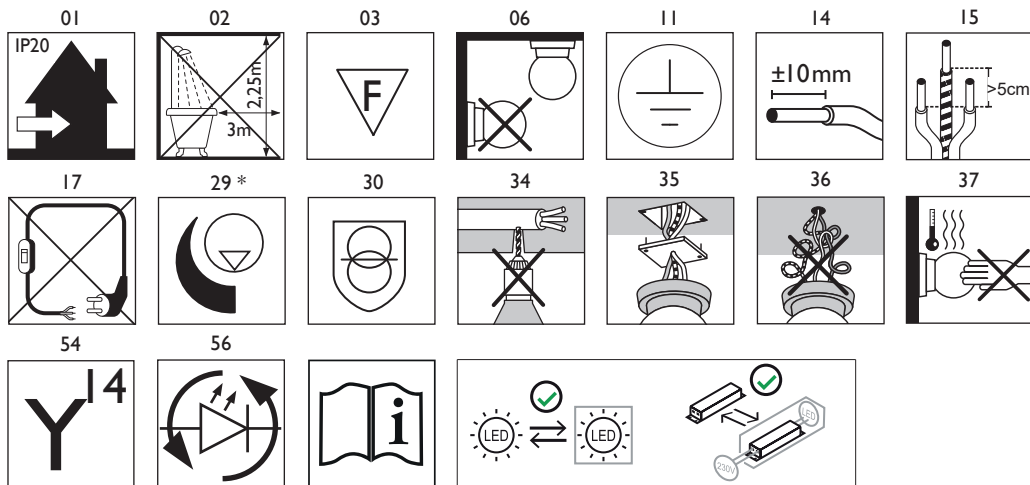

29\* Levante drivers are suitable for use with Trailing edge dimm

## A06/1D - A06/2D

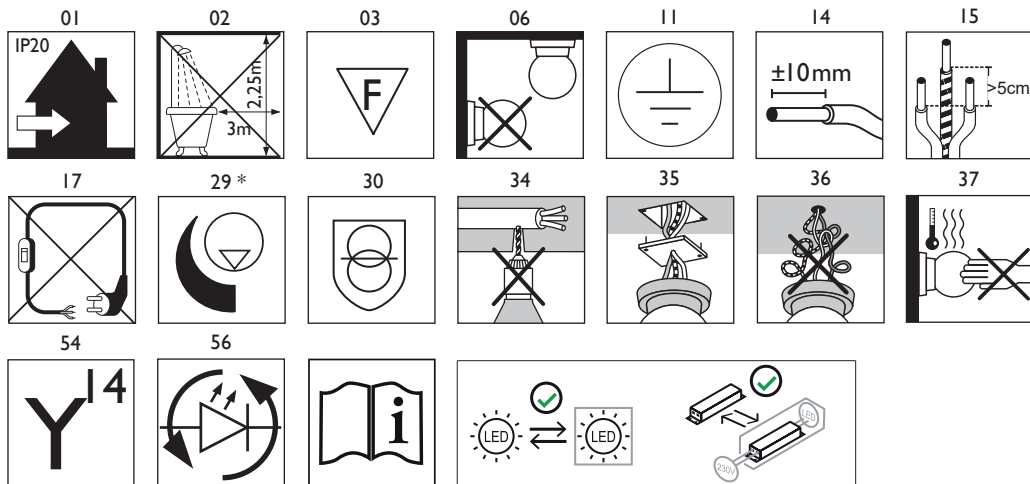

29\* Levante drivers are suitable for use with DALI - Push dimm

A06/1D  
A06/1T  
+  
A06C1

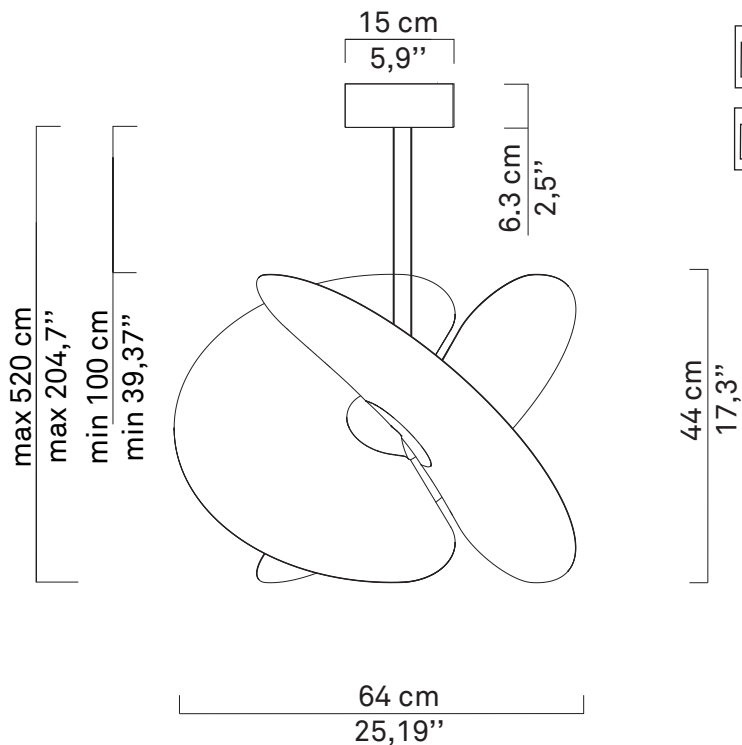

X1

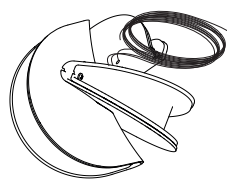

X1

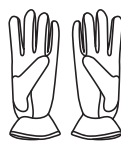

X1

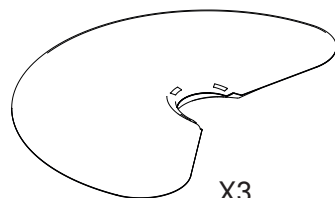

X3



x 1

**kg** 2,5 kg **lb** 5,51 lb

A06/2D  
A06/2T  
+  
A06C2

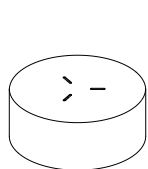
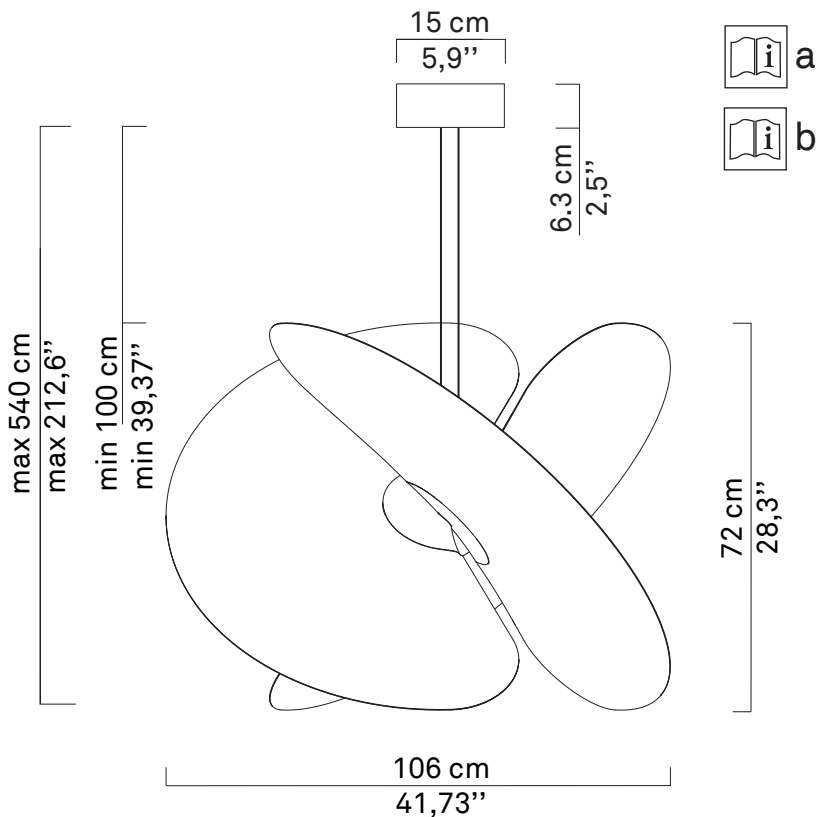

X1

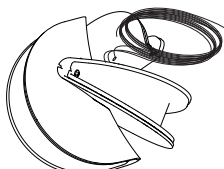

X1

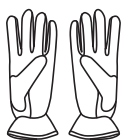

X1

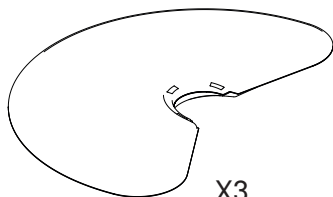

X3



x 1



x 6



x 1

**kg** 5,4 kg

**lb** 11,9 lb

# 1 | 1.1

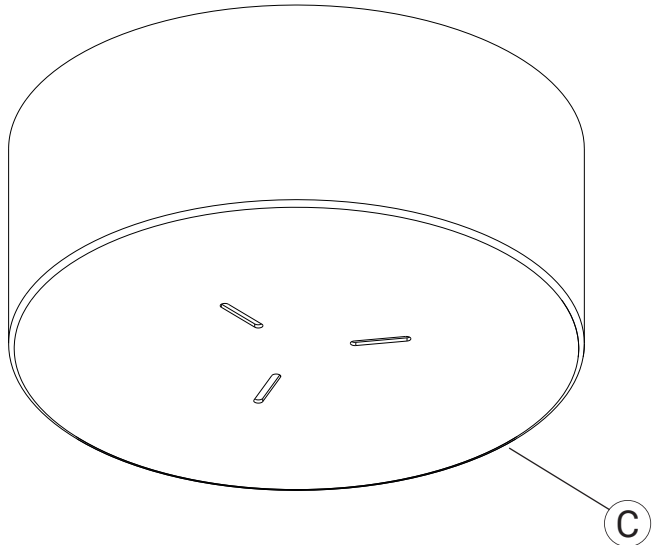
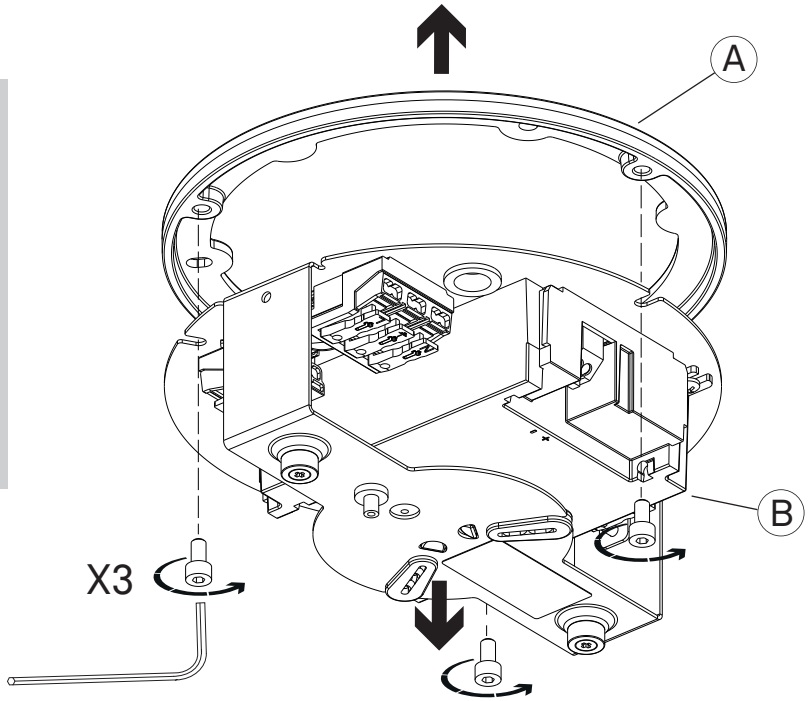
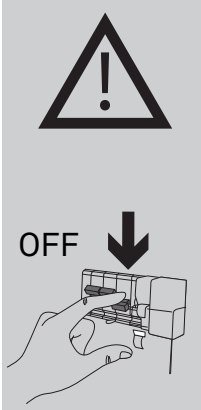

# 1.2

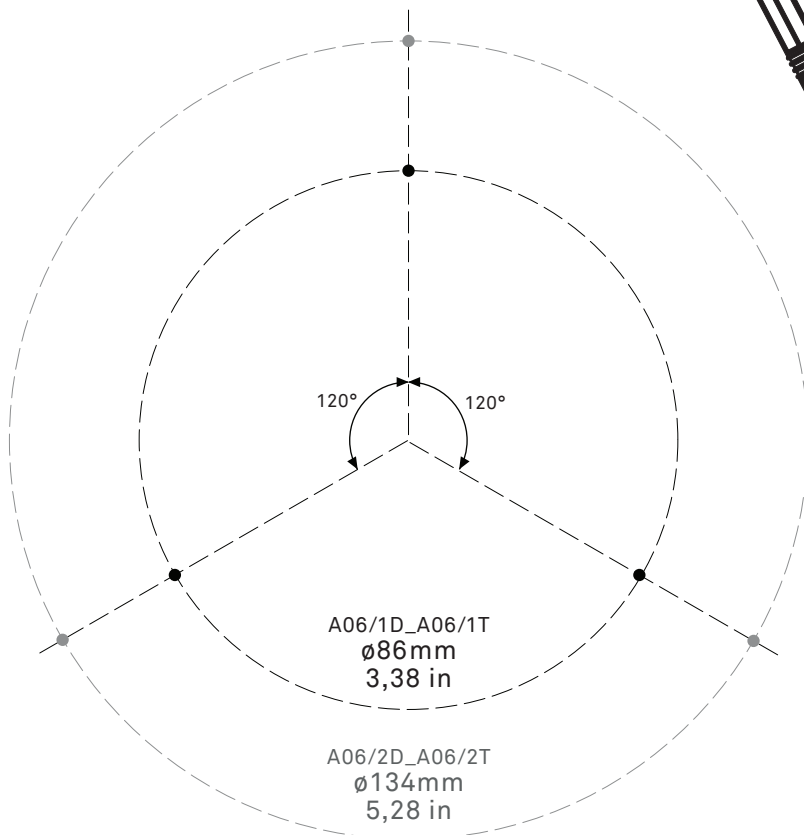
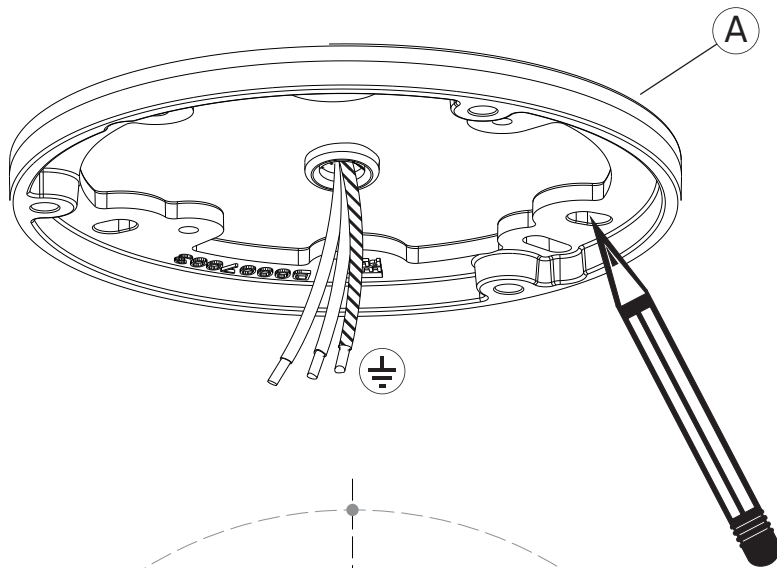

# 1.3

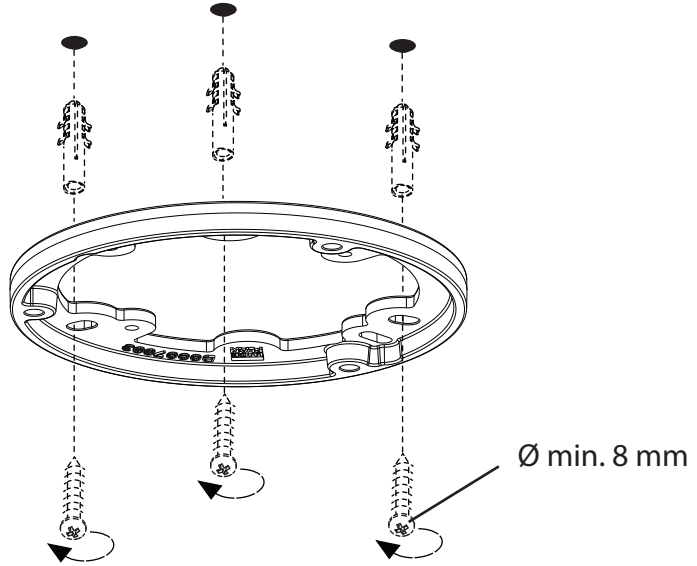

# 1.4

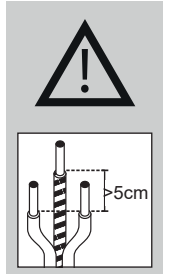
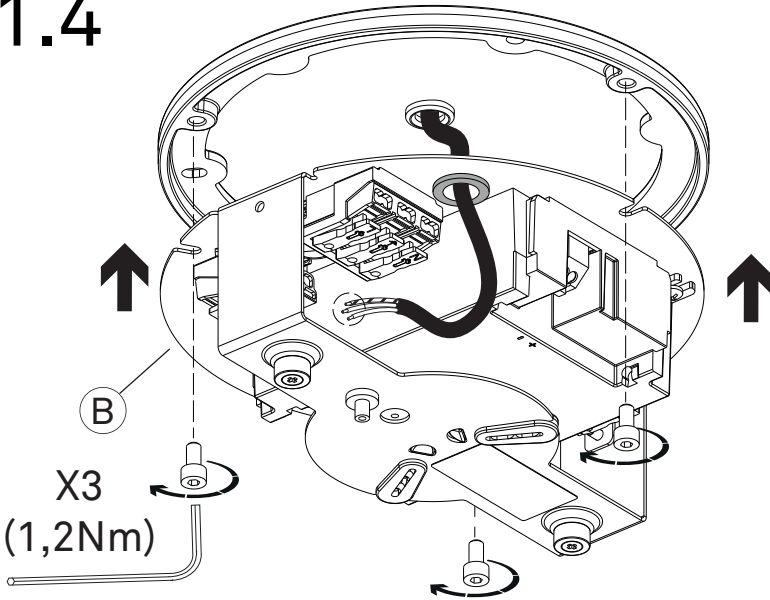

# 1.5

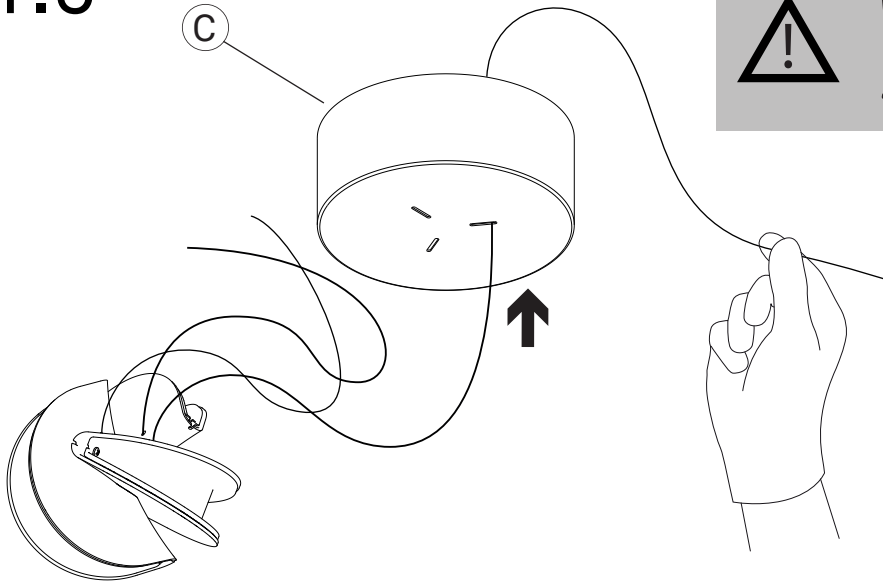

# 1.6

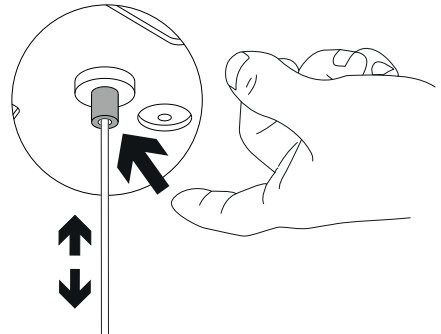
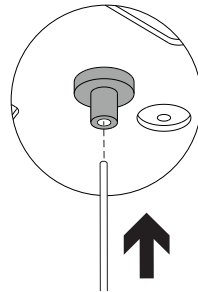
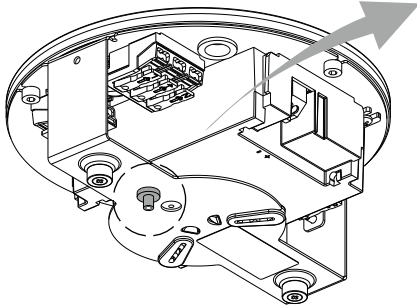

IT solo cavo in acciaio

EN steel wire only

DE nur stahlkabel

FR seulement câble en acier

ES cable de acero solamente



# 1.8

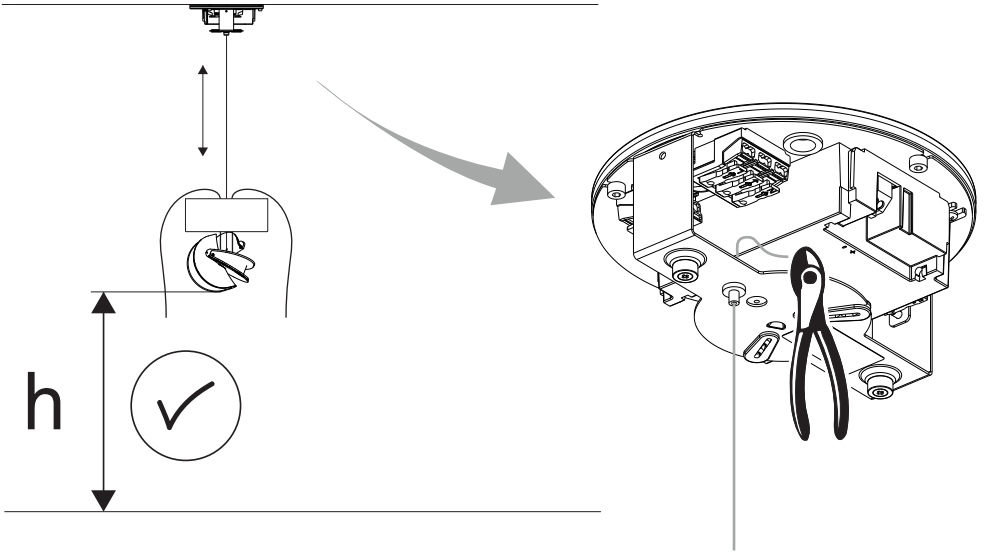

# 1.9

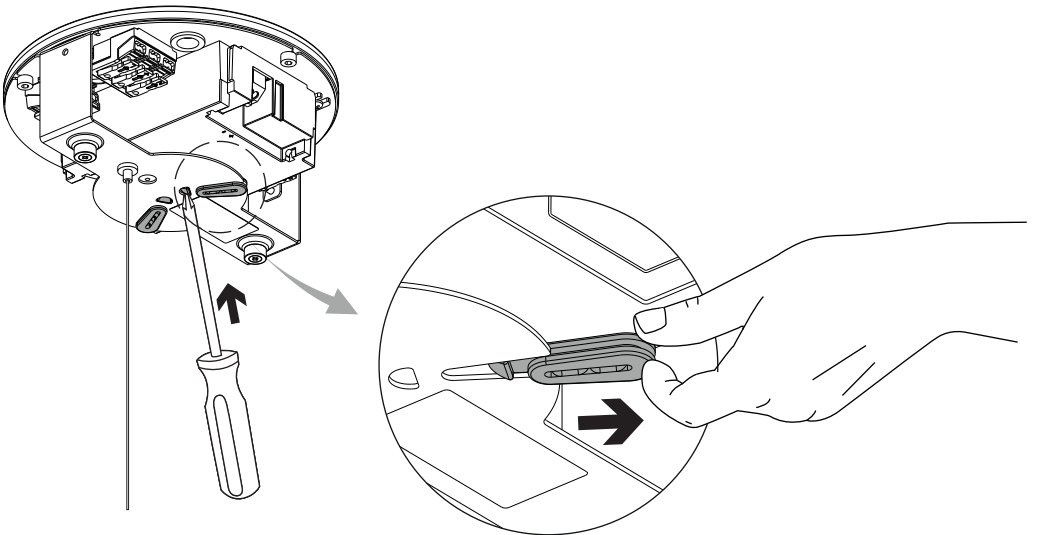

# 1.10

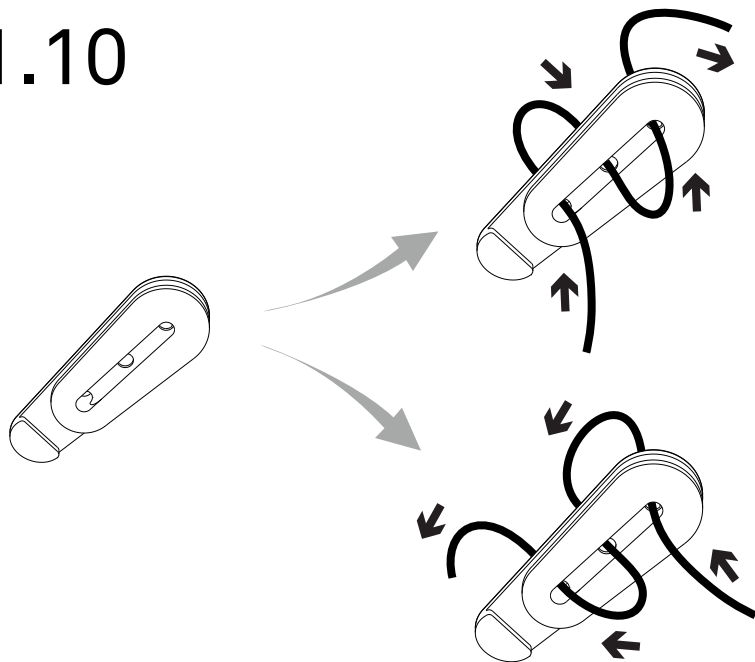

A06/1D  
A06/1T

A06/2D  
A06/2T

# 1.11

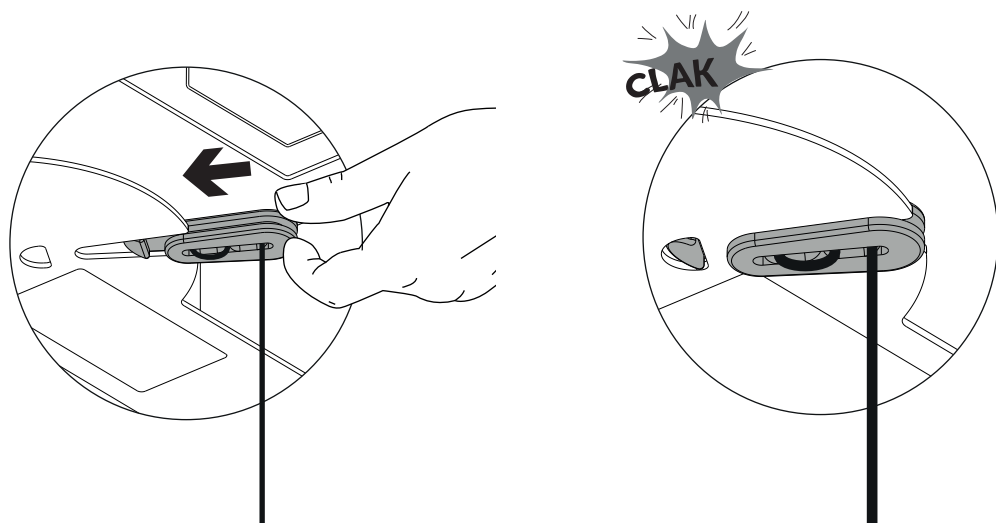

# 1.12

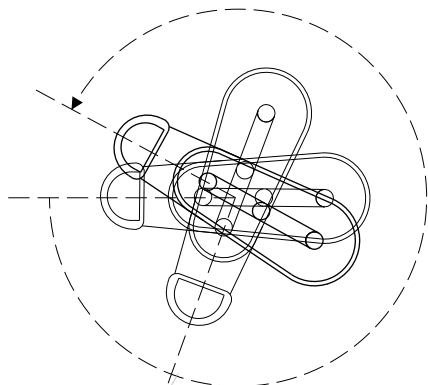
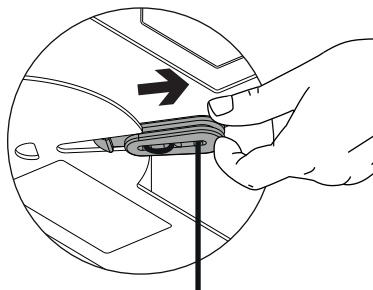
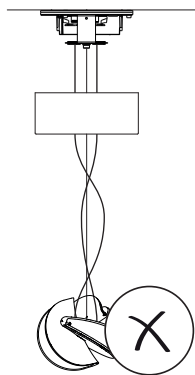

- IT** ruotare in senso orario o antiorario
- EN** rotate clockwise or counterclockwise
-  **DE** um im Uhrzeigersinn oder gegen den Uhrzeigersinn drehen
- FR** tourner dans le sens horaire ou antihoraire
- ES** gírelo en el sentido del reloj o contrarreloj

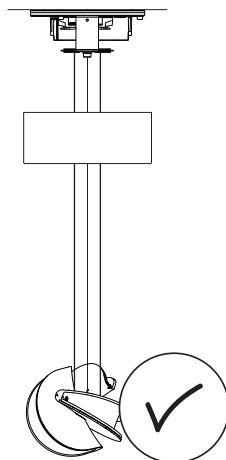
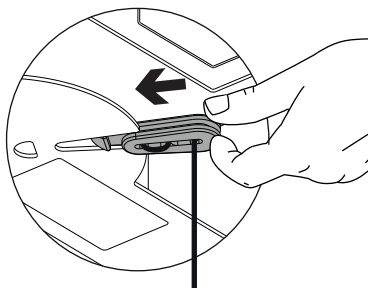

# 2 A06/1T \_ A06/2T

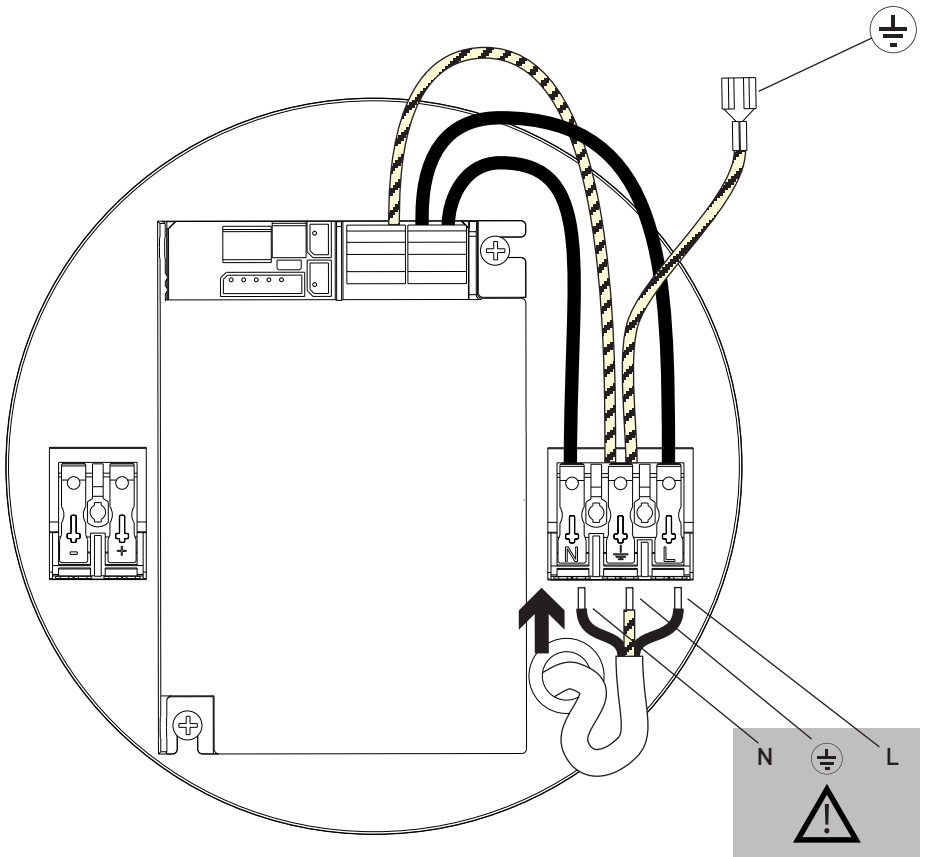

# A06/1D \_ A06/2D

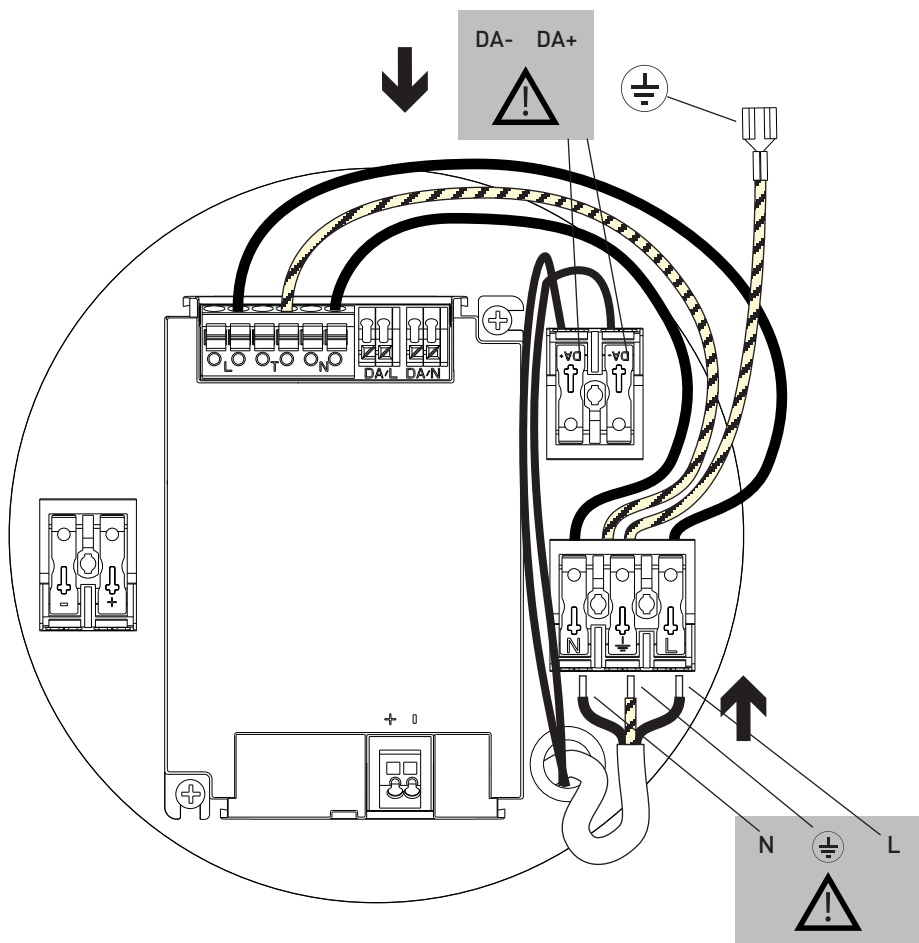

A06/1D \_ A06/2D

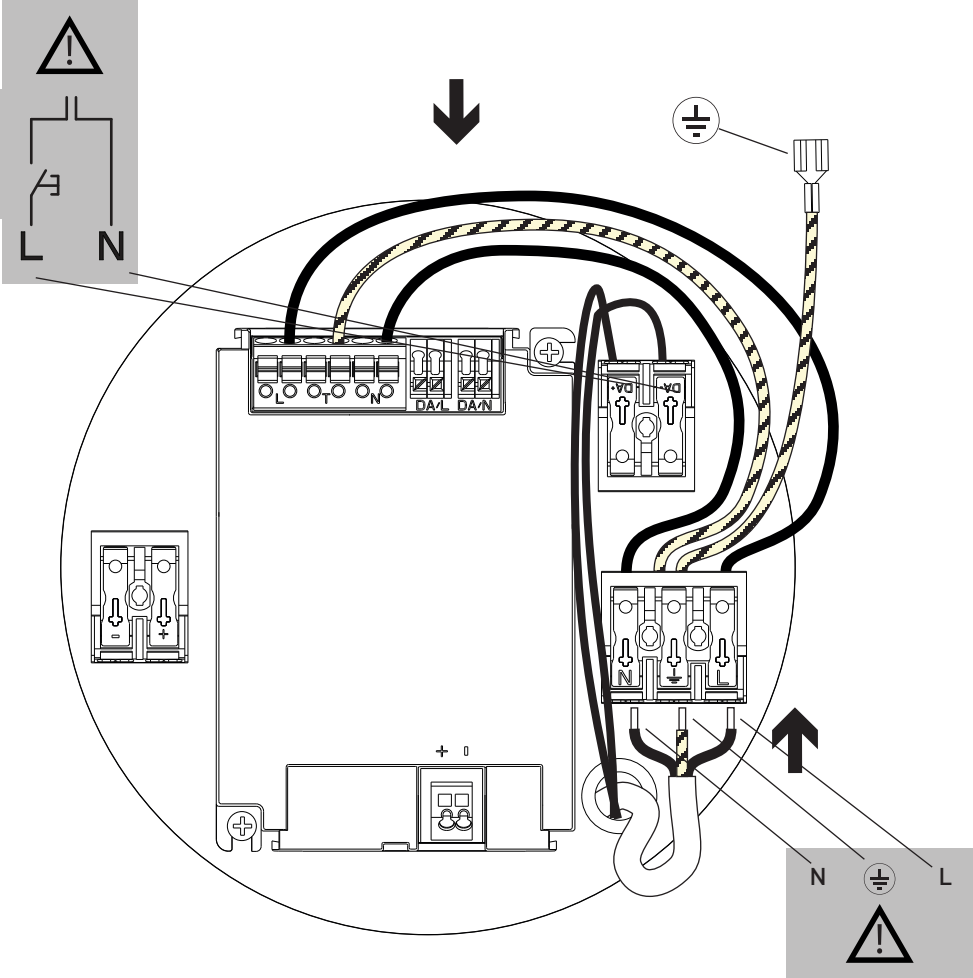
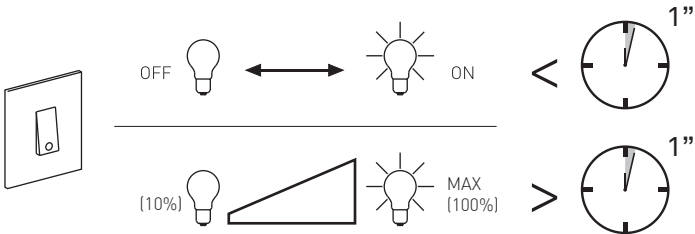

# 3 | 3.1

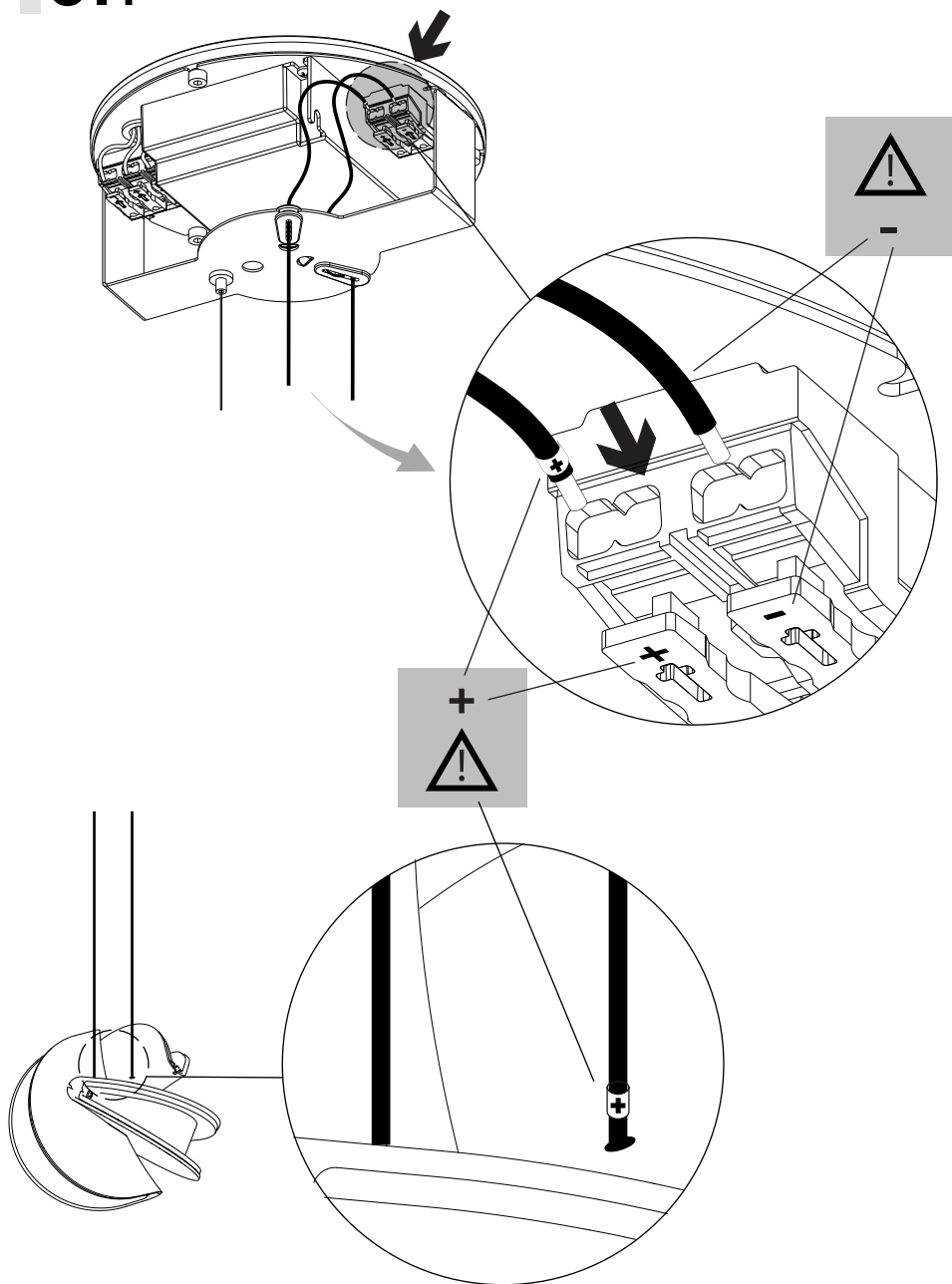

# 3.2

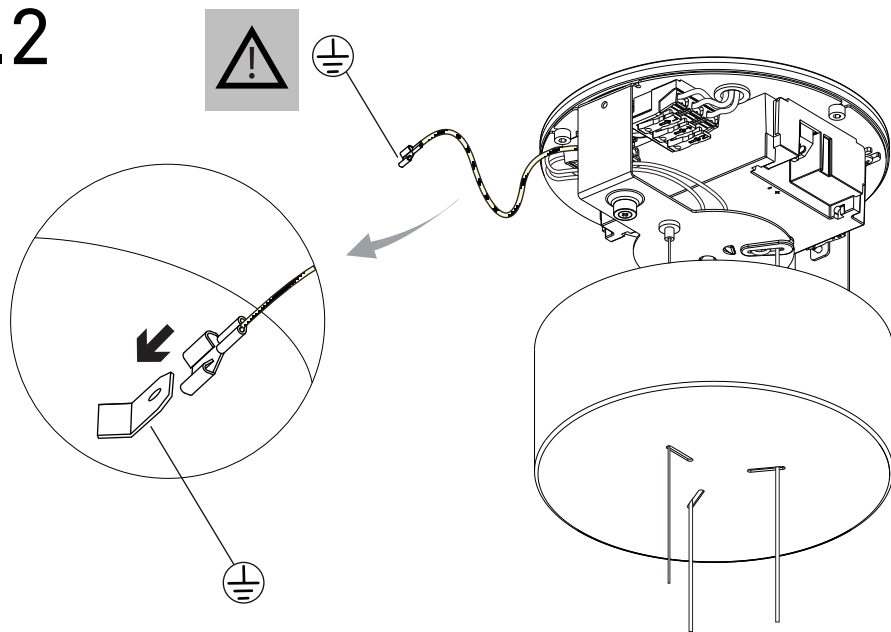

# 3.3

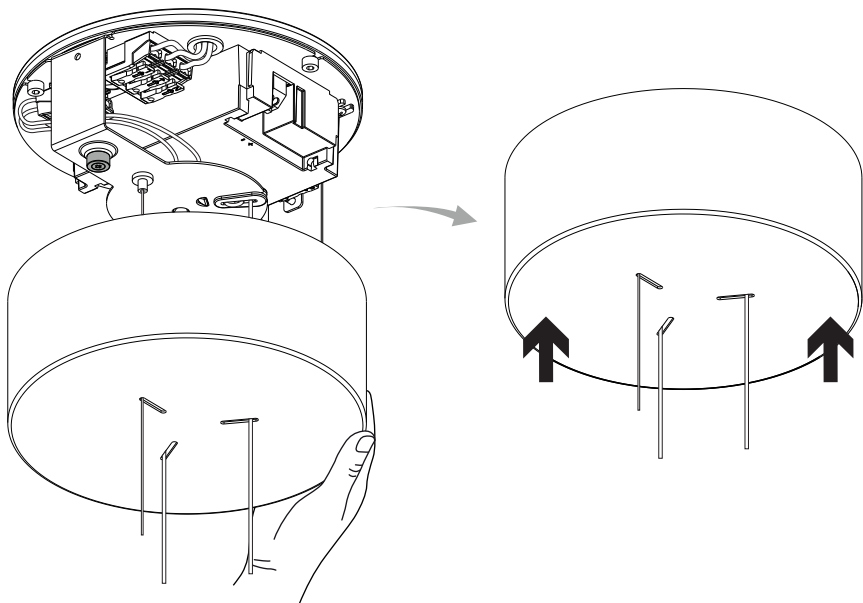

# 4

## A06/1D-A06/1T+A06C1

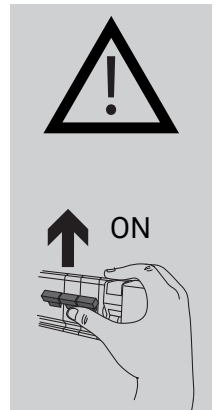
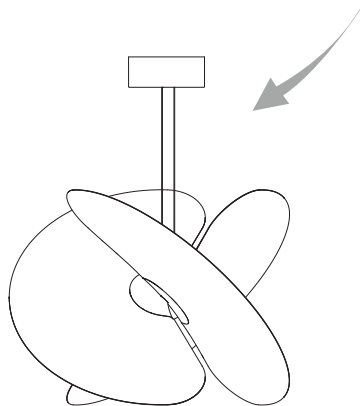
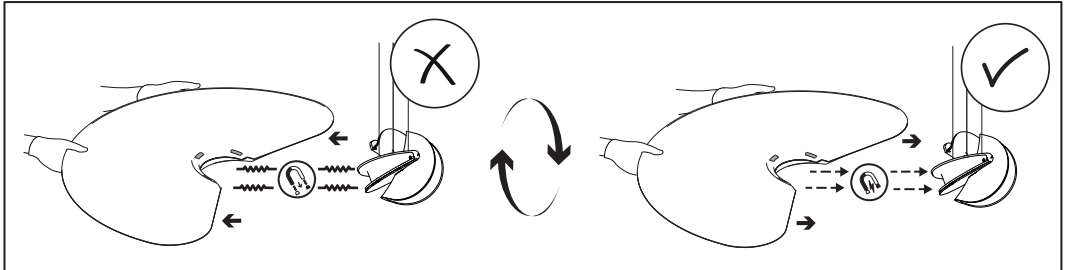
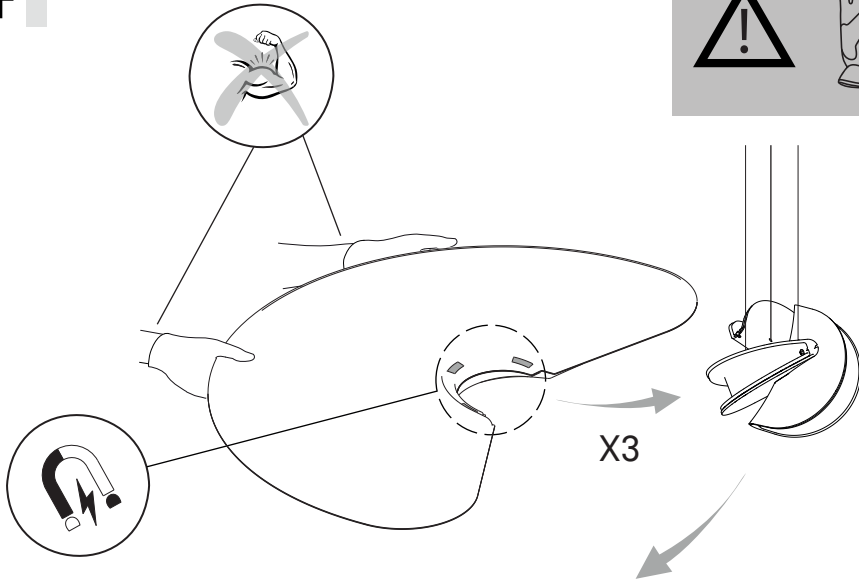

## A06/2D-A06/2T+A06C2

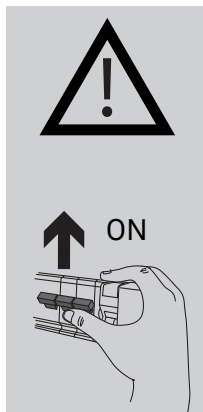
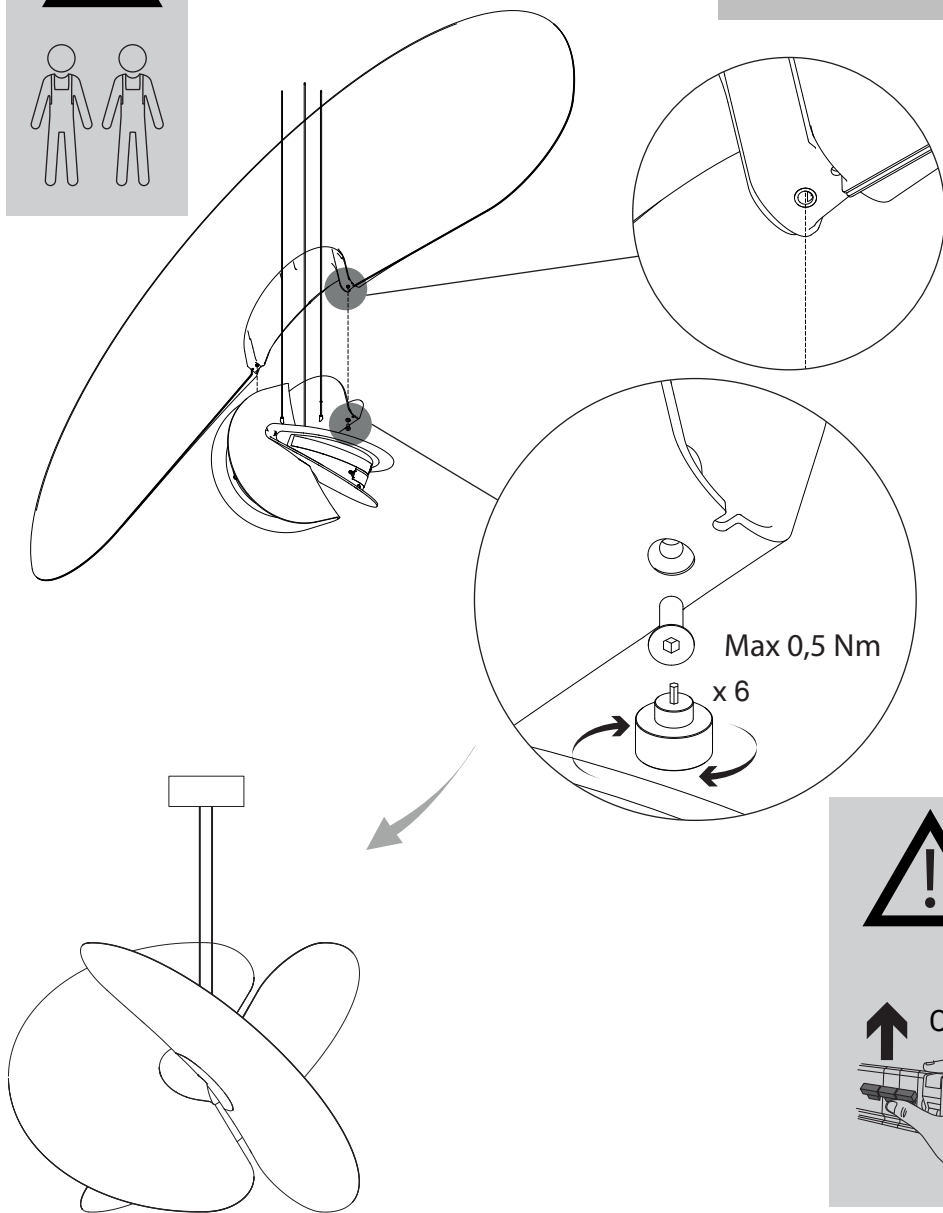
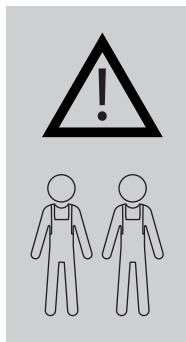

## ECODESIGN

### SYMBOL LEGEND

### LEGENDA DEI SIMBOLI

### ERLÄUTERUNG DER SYMBOLE

### LEGENDE DES SYMBOLES

### LEYENDA DE LOS SIMBOLOS



Replaceable light source by end-user  
Fonte luminosa sostituibile dal cliente finale  
Auswechselbare Lichtquelle durch den Endanwender  
Source lumineuse remplaçable par l'utilisateur final  
Fuente de luz reemplazable por el usuario final



Replaceable light source by a professional  
Fonte luminosa sostituibile da un professionista  
Auswechselbare Lichtquelle durch einen Fachmann  
Source lumineuse remplaçable par un professionnel  
Fuente de luz reemplazable por un profesional



Replaceable (LED only) light source by end-user  
Fonte luminosa (solo LED) sostituibile dal cliente finale  
Auswechselbare (nur LED) Lichtquelle durch den Endanwender  
Source lumineuse remplaçable (LED uniquement) par l'utilisateur final  
Fuente de luz reemplazable (sólo LED) por el usuario final



Replaceable (LED only) light source by a professional  
Fonte luminosa (solo LED) sostituibile da un professionista  
Auswechselbare (nur LED) Lichtquelle durch einen Fachmann  
Source lumineuse remplaçable (LED uniquement) par un professionnel  
Fuente de luz reemplazable (sólo LED) por un profesional



Non-replaceable light source  
Fonte luminosa non sostituibile  
Nicht austauschbare Lichtquelle  
Source lumineuse non remplaçable  
Fuente de luz no reemplazable

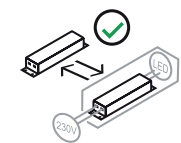

Replaceable control gear by a end-user  
Unità di alimentazione sostituibile dal cliente finale  
Austauschbares Vorschaltgerät durch einen Endanwender  
Pièce d'alimentation remplaçable par l'utilisateur final  
Unidad de alimentación reemplazable por el usuario final

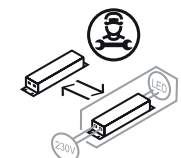

Replaceable control gear by a professional  
Unità di alimentazione sostituibile da un professionista  
Austauschbares Vorschaltgerät durch einen Fachmann  
Pièce d'alimentation remplaçable par un professionnel  
Unidad de alimentación reemplazable por un profesional

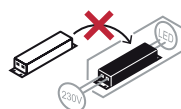

Non-replaceable control gear  
Unità di alimentazione non sostituibile  
Nicht austauschbares Vorschaltgerät  
Pièce d'alimentation non remplaçable  
Unidad de alimentación no reemplazable



5

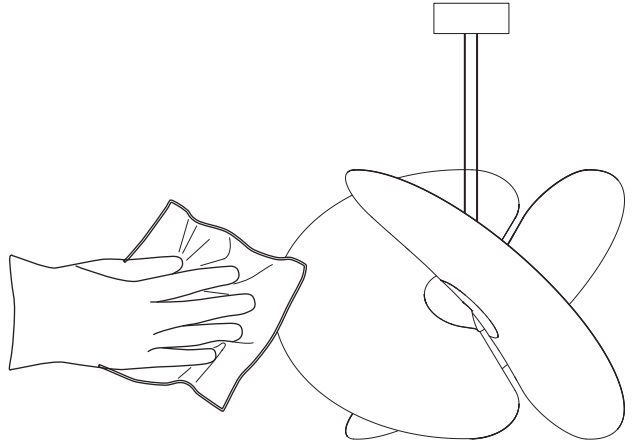
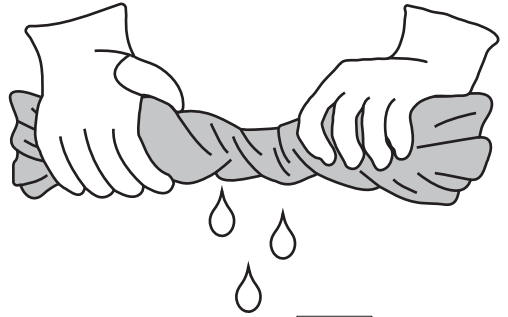
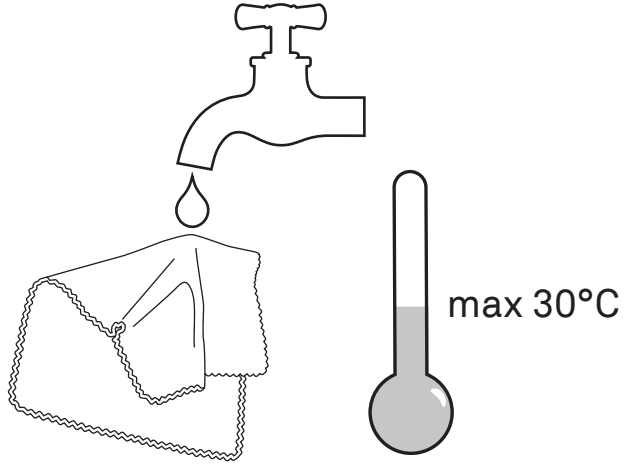
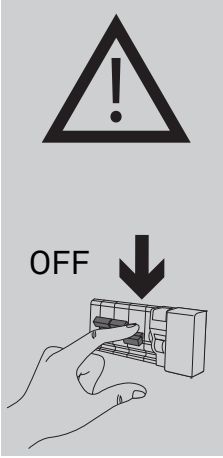









[www.luceplan.com](http://www.luceplan.com)

A060IH0001